

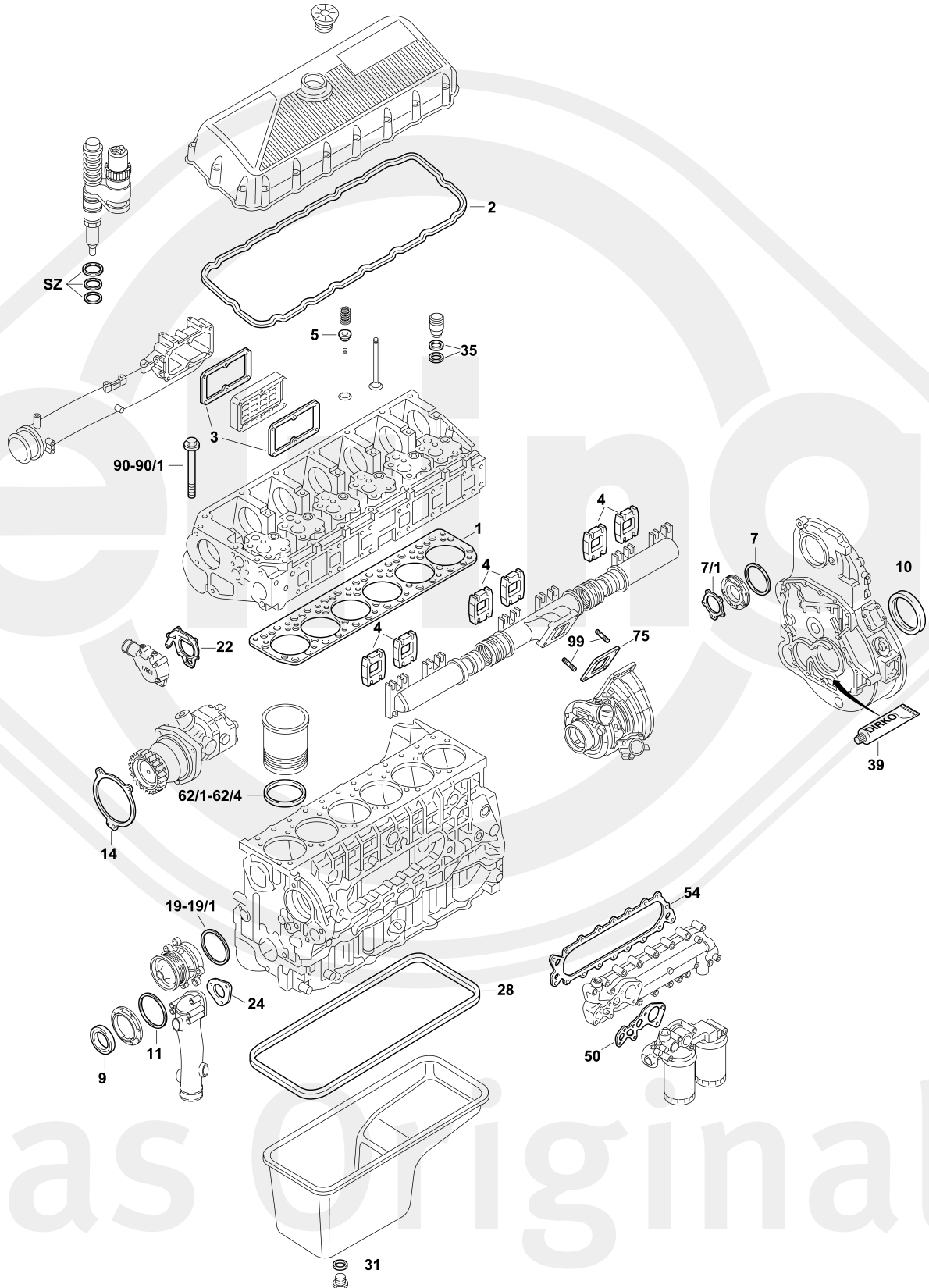

Das Original

Iveco

Cursor 13



Das Original









F3BE 3681 A/B/C/D/E/F/G

F3BE 0681 A/B/C/E/F/G/H/J/K/V



S ⊕*	650.010	1x	299 6302	–	F3BE 3681 A/B/C/D/E/F/G
S ⊕*	650.060	1x	299 6504	–	F3BE 0681 A/B/C/E/F/G/H/J/K/V
ES ⊕	689.930	1x	299 6303	–	F3BE 3681 A/B/C/D/E/F/G
ES ⊕	751.590	1x	299 2575	–	F3BE 0681 A/B/C/E/F/G/H/J/K/V
SZ	688.220	6x	504 110 736	–	–
ZLBS	650.020	6x	–	–	–
TLS	929.290	1x	–	–	–

1	538.980	1x	504 007 514	∅ 151 mm $\frac{\text{H}}{\text{h}}$ 1,50 mm	–
2	569.330	1x	500 309 014	–	–
3	584.800	2x	504 026 624	–	–
4	584.780	6x	504 154 280	–	–
5	558.930	12x	4010 1874	10x14/17,4x9,5 FPM	–
7		1x	1729 2281	126,59x3,53 FPM RD	–
7/1	584.772	1x	9944 8739	–	–
9	457.261	1x	4010 2683	100x130x14 KS RD VMQ	–
10	454.050	1x	4010 2693	130x160x14 KS LD VMQ	–
11	–	1x	1729 2681	–	–
14	–	1x	9944 7382	–	–
19		1x	1729 2281	126,59x3,53 FPM RD	–
19/1		1x	1729 2081	120,24x3,53 FPM RD	–
22	584.790	1x	500 362 150	–	–
24		1x	9946 6940	–	–
28	542.070	1x	504 024 777	–	–
31	834.831	1x	9948 9022	–	–
35		12x	1727 9081	26,7x1,7 FPM RD	–
39	036.164	1x	–	70 ml	 Dirko™ HT
50		1x	504 015 752	–	–
54	588.500	1x	9849 7873	–	–
62/1	–	6x	9944 8193	$\frac{\text{H}}{\text{h}}$ 0,08 mm	–
62/2	–	6x	9944 8192	$\frac{\text{H}}{\text{h}}$ 0,1 mm	–
62/3	–	6x	9944 8190	$\frac{\text{H}}{\text{h}}$ 0,12 mm	–



Das Original



F3BE 3681 A/B/C/D/E/F/G

F3BE 0681 A/B/C/E/F/G/H/J/K/V



62/4	-	6x	500 378 983	$\pm 0,14$ mm	-
75	588.730	1x	9945 6095	-	-
90	-	20x	9849 5527	M18x2x196	-
90/1	-	6x	9849 5528	M18x2x175	-
99		2x	9946 3138	M12x1,75x30	-