

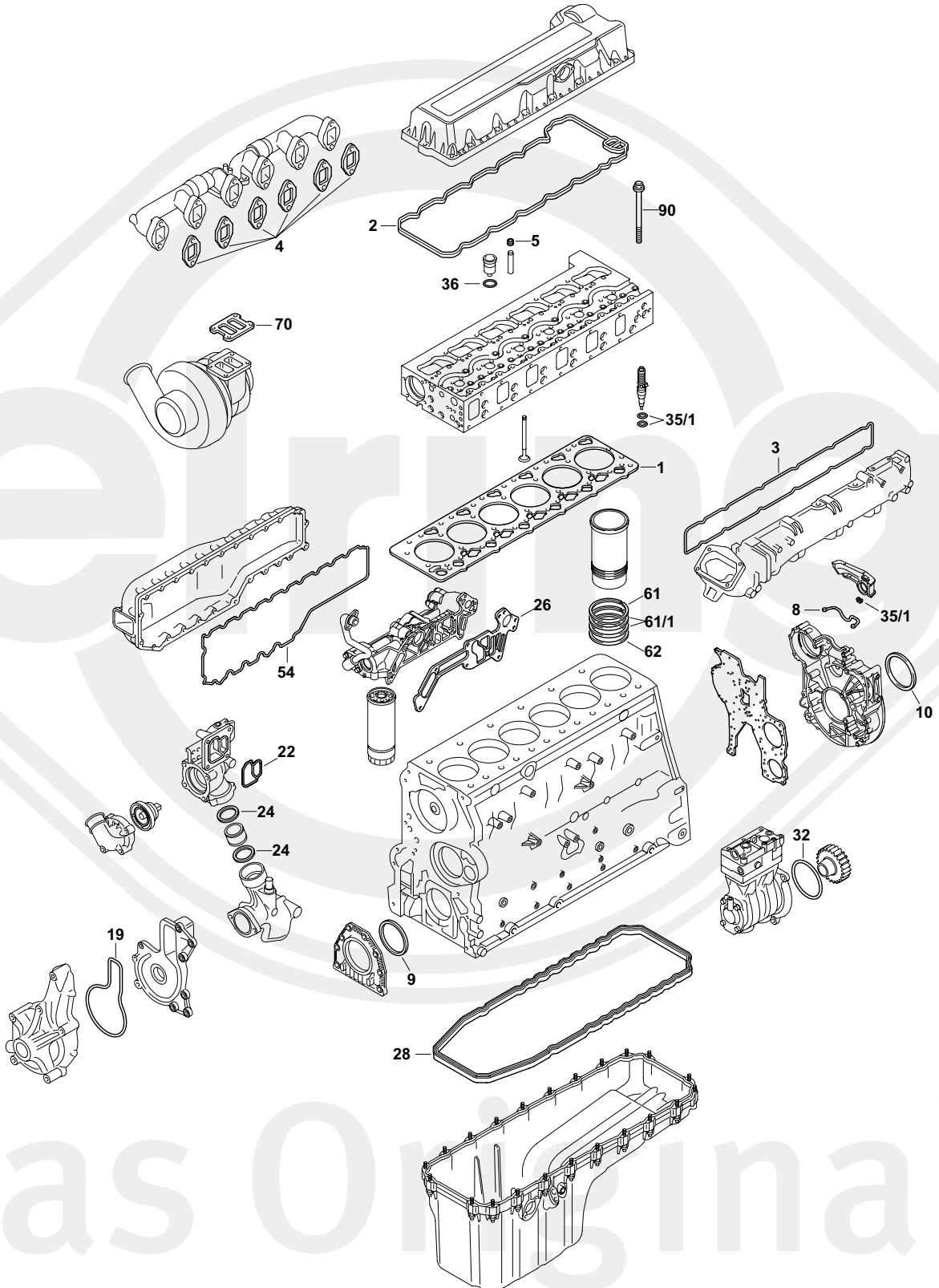

Das Original





Mack

MP8



Das Original







S ⊕ *	309.530	1x	-	-	-
ES ⊕	038.580	1x	21 539 731	-	
ES ⊕	899.340	1x	21 768 034	-	-
ES ⊕	900.350	1x	-	-	
CS *	008.190	1x	-	-	 PLASTIC
CS *	008.200	1x	-	-	 FE AL
ZLBS	755.672	6x	270 950	-	-
AAS	196.640	1x	-	-	-
ZKS	136.680	1x	21 345 131(38x)	M16x2,0x199	-

1	548.501	1x	21 510 072	∅ 147,3 mm \pm 1,25 mm	-
2	156.352	1x	20 538 793	-	-
3	038.630	1x	20 805 850	-	-
4	381.570	6x	20 855 371	-	-
5	038.690	24x	20 864 662	8x11/14,8x10,9 FPM	-
8	321.770	1x	20 817 742	-	-
9	000.270	1x	21 347 087	136x159x13 AW RD PTFE/ACM	-
10	453.851	1x	85 108 352	180x205x15 AW LD PTFE/ACM	-
10	081.460	1x	1 543 896	180x205x15 A/BS LD FPM	-
19	545.790	1x	21 415 427	-	-
22	369.111	1x	21 298 915	-	-
24	390.030	2x	1 547 254	49x60x7 EPDM A	-
26	357.780	1x	20 787 167	-	-
28	156.361	1x	20 541 940	-	-
28	156.373	1x	20 515 881	-	 PLASTIC  FE AL
32	728.070	1x	992 065	-	-
35/1	369.521	6x	276 948	-	-
36	390.490	6x	20 536 487	30x3 VMQ RD	-
39/1	475.152	2x	21 185 132	-	-
54	712.840	1x	21 294 062	-	-



MP8



61		6x	470 922	140,5x2,4 EPDM RD	
61/1		12x	470 190	142,6x5,8 FPM RD	
62	813.583	6x	424 833	142,6x5,8 FPM RD	
70	753.238	1x	470 939	-	-
90	136.680	4x	21 345 131	M16x2,0x199	-